

LS

TRINCIATRICE LATERALE
VERGE MOWER



Trinciatrice con scarico laterale progettata per la manutenzione dei canali evitando la caduta in acqua del materiale trinciato e per tutte le applicazioni in cui il materiale deve essere scaricato lateralmente.

Verge mower with side discharge designed for the maintenance of water ways avoiding the discharge of the cut material in the water and for all those applications where the material needs to be discharged to the side





Doppio cofano **Double skin chassis**



Robusto nastro in gomma rinforzata
Heavy duty rubber conveyor belt

OPTIONAL





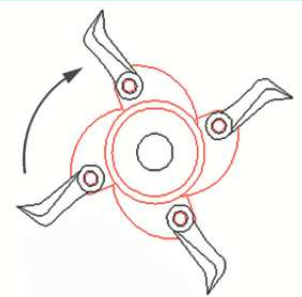

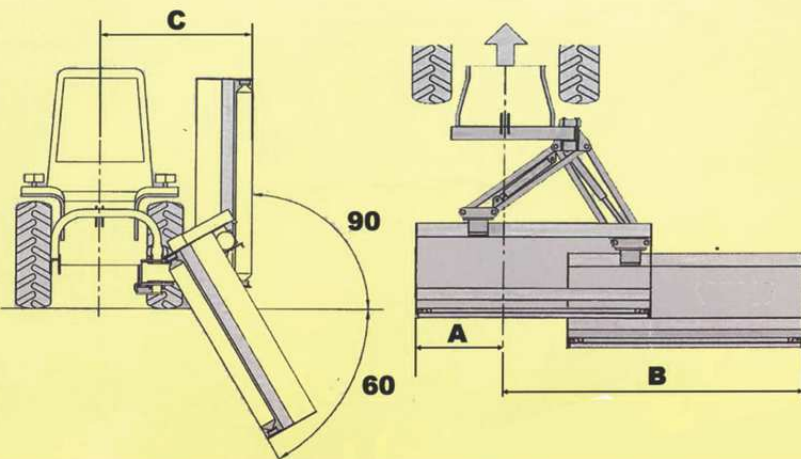

Impianto idraulico indipendente pompa serbatoio
Independent hydraulic pump and oil tank



Speciale rotore ANTIURTO per ridurre i danni causati da urti
Unique ANTI SHOCK rotor design to reduce damages when hitting hard objects



	ES				ES			
MOD	140	160	180	200	140	160	180	200
A	620				340			
B	2100	2230	2490	2620	2380	2510	2770	2900
C	1350				1630			

MODELLO						
	HP	cm	cm	nr	nr	Kg
LS140	80-100	140	152x190X110	12	24	720
LS160	80-100	155	167x190X110	14	28	740
LS180	80-100	180	192x190X110	16	32	760
LS200	80-100	195	210x190X110	18	36	790

CONCEPT
MACCHINE AGRICOLE **ERUGINI**

Via Dell'Artigianato 11 - 47014 MELDOLA - ITALY
PHONE: +390543494602 - FAX: +390543494727
Email: sales@conceptagri.com

Dati, caratteristiche e illustrazioni, sono puramente indicativi e non impegnativi. / Technical data, particulars and illustrations are merely indicative and not binding. / Les données, les caractéristiques et les illustrations sont tout simplement à titre indicatif et n'engagent pas. / Änderungen vorbehalten.

